







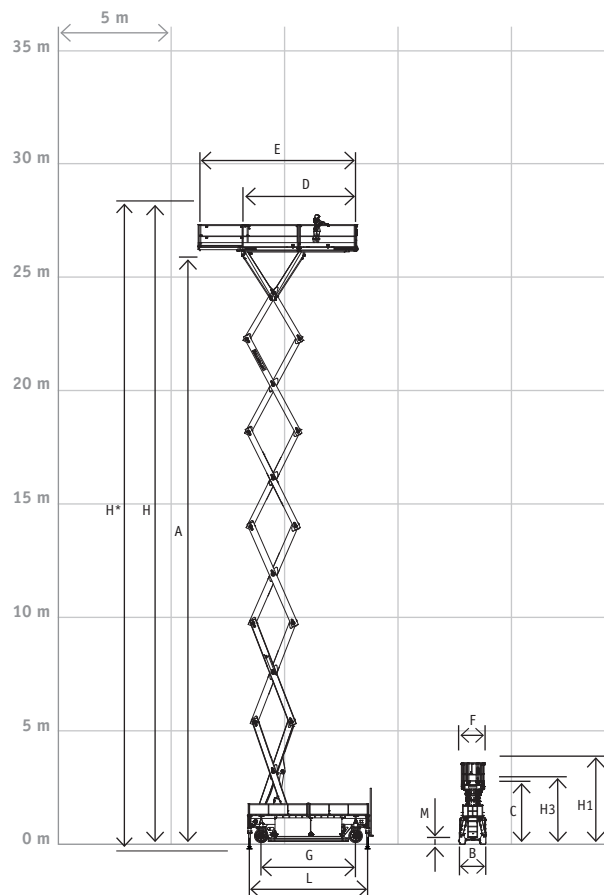

KENMERKEN / FEATURES / MARKMALE			
	HL-285 E13 4WDS	HL-285 E13 4WDS/N	HL-330 E14 4WDS/N
H (max.)	± 28.20 m	± 28.20 m	± 33.00 m
H* (max.)	± 28.25 m	± 28.25 m	± 33.05 m
A (max.)	± 26.20 m	± 26.20 m	± 31.00 m
C (min.)	± 2.95 m	± 2.95 m	± 3.11 m
DxF (min.)	5.21 x 1.30 m	5.21 x 1.30 m	6.40 x 1.20 m
ExF (max.)	7.41 x 1.30 m	7.41 x 1.30 m	8.40 x 1.20 m
H1	4.10 m	4.10 m	4.28 m
H3	3.21 m	3.21 m	3.20 m
LxB	5.60 x 1.32 m	5.60 x 1.32 m	6.60 x 1.40 m
G	4.19 m	4.19 m	4.99 m
M	175 mm	175 mm	210 mm
∅ D	± 3.45 m	± 3.60 m	± 4.04 m
 (max.)	750 kg (2 pers. + 590kg)	750 kg (2 pers. + 590kg)	600 kg (2 pers. + 440kg)
 (max.)	750 kg (2 pers. + 590kg)	750 kg (2 pers. + 590kg)	600 kg (2 pers. + 440kg)
 (sec.)	156/126 sec.	156/126 sec.	168/140 sec.
	2.3 km/h	2.3 km/h	2.8 km/h
	0.5 km/h	0.5 km/h	0.5 km/h
	28 x 10 x 22	28 x 10 x 22	28 x 12 x 22
 (max.)	± 25%	± 25%	± 25%
	1150 Ah/k5/48 V	1150 Ah/k5/48 V	840 Ah/k5/80 V
	18.770 kg	19.370 kg	23.950 kg



NEDERLANDS	ENGLISH	DEUTSCH			
<b>OPTIES</b>	<b>OPTIONS</b>	<b>OPTIONEN</b>			
Besturing met snelsluitstekker	Controlbox with quick disconnect	Plattformsteuerung mit Schnellstecker	●	●	●
Urenteller	Hourmeter	Stundenzähler	●	●	●
230V voorziening op platform	230V supply on platform	230V Versorgung an der Plattform	○	○	○
Omvormer 230V	Converter 230V	Umformer 230V	○	○	○
Rijden op volle hoogte	Driving at full height	Fahren in voller Höhe	●	●	●
Rijden, proportioneel	Driving, proportional	Fahren, proportional	●	●	●
Heffen, proportioneel	Lifting, proportional	Heben, proportional	●	●	●
Sperfunctie	Differential lock	Differentialsperre	●	●	●
Vierwiel aandrijving (4WD)	Four wheel drive (4WD)	Allradantrieb (4WD)	●	●	●
Vierwielstuur (S)	Four wheel steering (S)	Allradlenkung (S)	●	●	●
Nivelleerstempels (N)	Levelling jacks (N)	Nivellierstützen (N)	--	●	●
Smeersysteem Easy Lube	Lubrication system Easy Lube	Schmiersystem Easy Lube	●	●	●
Smeersysteem Auto Lube	Lubrication system Auto Lube	Schmiersystem Auto Lube	○	○	○
<b>VEILIGHEIDSVORZIENINGEN</b>	<b>SAFETY FEATURES</b>	<b>SICHERHEITSEINRICHTUNGEN</b>			
Beschermhek	Scissor skirt	Schutzgitter	●	●	●
Daalbeveiliging	Descent safety	Senkschutz	--	--	--
Flitslampen	Flashing beacons	Blinkleuchten	○	○	○
Rij-alarm (akoestisch)	Drive alarm	Fahrwarnung (akustisch)	●	●	●
Nooddaalvoorziening	Emergency descent	Notsenkvorrichtung	●	●	●
<b>TOEPASSING</b>	<b>APPLICATION</b>	<b>ANWENDUNG</b>			
Voor gebruik in gesloten ruimten	Indoors	In geschlossenen Räumen	●	●	●
Voor gebruik buiten	Outdoors	Im Freien	--	●	●
Toelaatbare min. omgevingstemperatuur	Certified min. temperature	Zul. Tiefsttemperatur	-15°C	-15°C	-15°C